

# Master/Sub Intercom



- Press-to-talk and handset voice-actuation
- Electronic tremolo and LED call-in, staying
- Pre-tone sounding at sub, when selected
- Selective, Group or All Call

- Trunk cable wiring: homerun or looped or intermix

**NEM-10/C** 10-call master  
**NEM-20/C** 20-call master  
**NEM-30/C** 30-call master  
**NEM-40/C** 40-call master

**NEM-10/A/C** 10-call master  
**NEM-20/A/C** 20-call master  
**NEM-30/A/C** 30-call master  
**NEM-40/A/C** 40-call master

**NB-L**, Ceiling sub  
**NA-NE** Flush-mount sub  
**NA-T/A** Handset sub

**NA-A** Desk/wall sub  
**NA-AN** Desk/wall sub, Privacy  
**NE-JA** Weather-resistant sub station

**NEM-50, NEM-50A** 50-call master  
**NEM-60, NEM-60A** 60-call master (photo)  
**NEM-70, NEM-70A** 70-call master  
**NEM-80, NEM-80A** 80-call master  
**NEM-90, NEM-90A** 90-call master  
**NEM-100, NEM-100A** 100-call master  
**NEM-110, NEM-110A** 110-call master  
**NEM-120, NEM-120A** 120-call master

**Options**

**NAR-6A**  
Call button for NB-L, etc.

**NBR-7AS**  
Bathroom pullcord

**NB-U**  
Music adaptor → P.99

**IER-2**  
Call extension → P.106

**NEW-5**  
Dual-master call adaptor for NEM-n(A)/C (n=10,20,30,40) → P.99  
For health care application → P.97

## Communication network & wiring

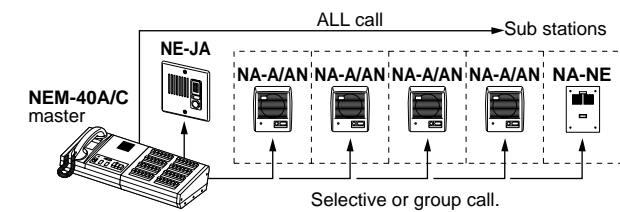

Run parallel cables to each NA sub station (in the same conduit).

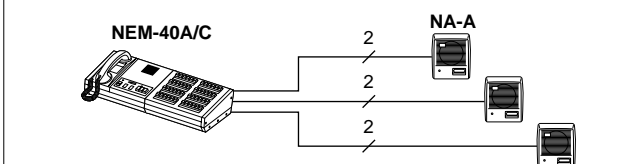

Run multi-conductor cable throughout system.

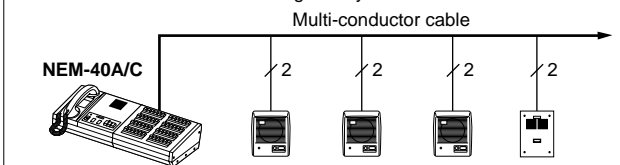

Run multi-conductor cables up to junction box, then run parallel cables to each NA sub station.

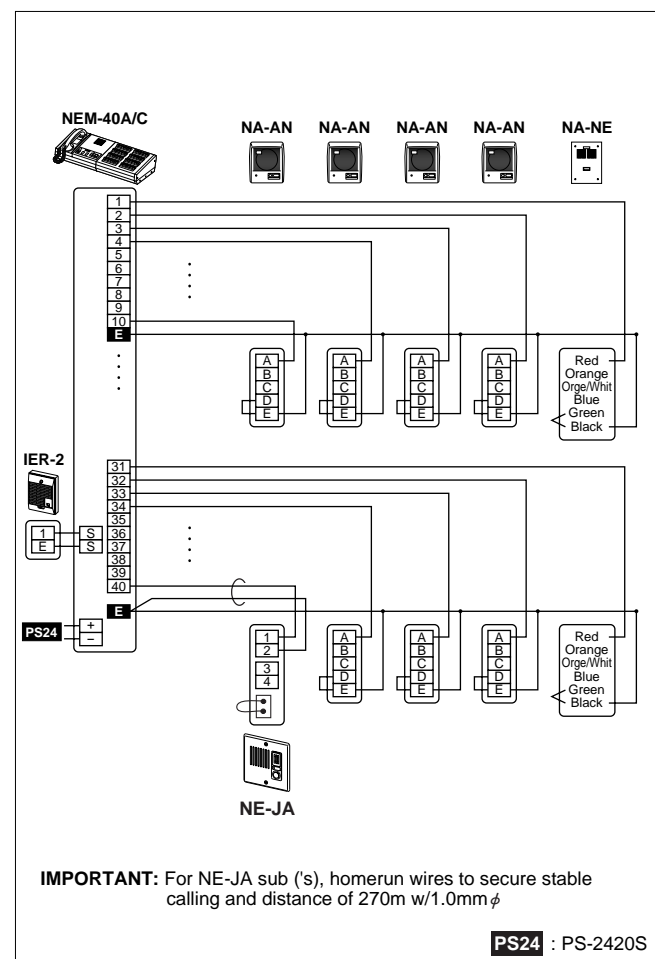
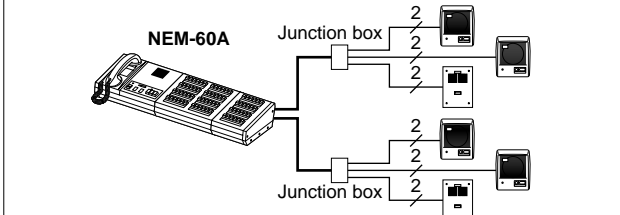

### Wiring call button

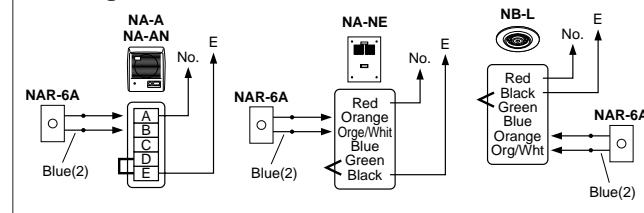

### System Components

#### Master stations

Capacity	Press-to-talk	Press-to-talk & Handset	Power supply
10-call	<b>NEM-10/C</b>	<b>NEM-10A/C</b>	One PS-2420S
20-call	<b>NEM-20/C</b>	<b>NEM-20A/C</b>	
30-call	<b>NEM-30/C</b>	<b>NEM-30A/C</b>	
40-call	<b>NEM-40/C</b>	<b>NEM-40A/C</b>	
50-call	<b>NEM-50</b>	<b>NEM-50A</b>	/1: 110V AC /5: 240V AC /7: 230V AC /7.A: 24V DC(CE) 2 × PS-2420S's (fou up to 80 subs). 3 × PS-2420S's (fou 81 ~ 120 subs).
60-call	<b>NEM-60</b>	<b>NEM-60A</b>	
70-call	<b>NEM-70</b>	<b>NEM-70A</b>	
80-call	<b>NEM-80</b>	<b>NEM-80A</b>	
90-call	<b>NEM-90</b>	<b>NEM-90A</b>	
100-call	<b>NEM-100</b>	<b>NEM-100A</b>	
110-call	<b>NEM-110</b>	<b>NEM-110A</b>	
120-call	<b>NEM-120</b>	<b>NEM-120A</b>	

#### Sub stations

- NA-A** Desk/wall
- NA-AN** Desk/wall, privacy
- NE-JA** Weather-resistant
- NA-NE** Flush mount
- NB-L** Ceiling mount

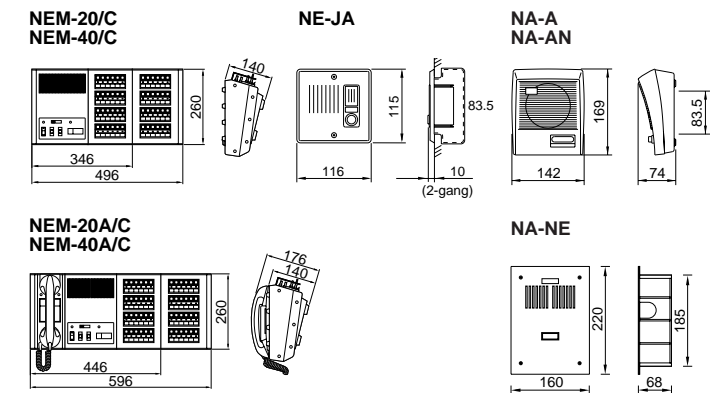

### Specifications (NEM)

Power source	24V DC.	
Consumption	1~40-call: 45W max. 2.5W standby. 41~80-call: 140W. 7.5W standby. 81~120-call: 180W max. 7.5W standby.	
Power supply	PS-2420S, PS-2420UL. AC plug in (50~120-call)	
Communication	Sub calls in w/tone & LED, staying. Press a lit selector and press TALK to transmit, release to listen, or lift handset. Sub, upon selected, hears pretone and voice. Reply handsfree.	
Output	500mW max., adjustable. All Call: w/ALL CALL switch (6W, 12W). Group call of 10 subs: w/TALK switch (3W).	
Wiring	2 wires per sub, non-twisted (1 common + no. NA subs)	
Distance	0.65mmø	0.8mmø
• NEM to NA subs	130m	200m